

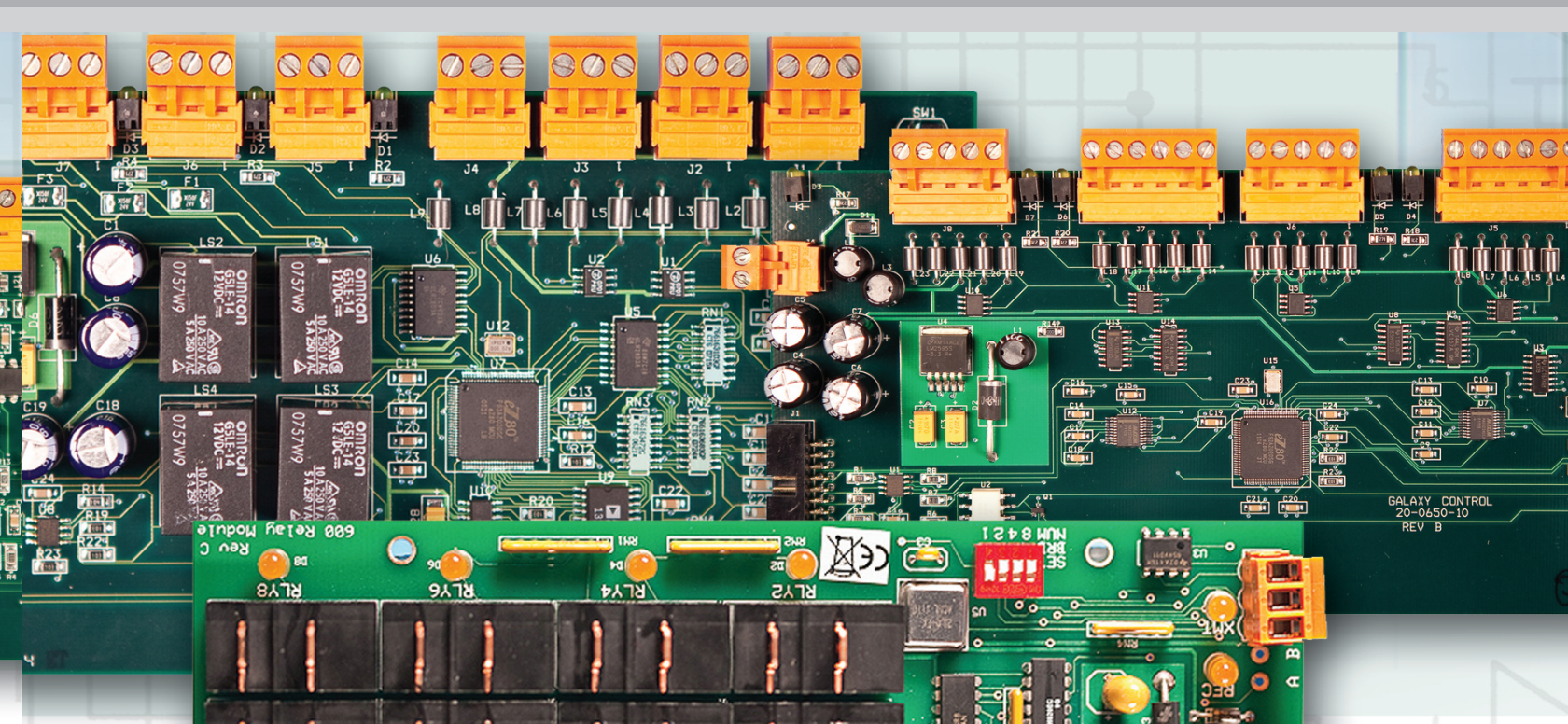

# SYSTEM GALAXY HARDWARE

## 635-Series



# 635-SERIES CONTROL PANELS

Galaxy's 635-series Control Panel provides the most flexible, reliable, and complete access control & security management solution available. The 635-series hardware is robust and capable of supporting virtually any security situation.

## Flexible • Expandable • Complete

Our 635-series Control Panel touts an unsurpassed flexibility that makes it simple to integrate system hardware with the full-featured System Galaxy software. Galaxy supports any combination of access control, biometrics, alarm & monitoring equipment, DVR/CCTV surveillance equipment, visitor & personnel verification, time & attendance, elevator controls, and more.

Galaxy 635-series control panels are modular and easily expanded. Each panel can be uniquely configured to fit the specific requirements of any facility. The panels accommodate the 635-series interface boards in any combination. Inputs, outputs, relays, card readers, and RS-485 devices can coexist in the same panel. So there is no reason to buy more equipment than you need.

635-series products are brand-neutral and fully compatible with the complete range of technologies, including smart card, biometric, proximity, barcode, magnetic swipe and wireless. And because the communication ports are designed to work independently, you can intermix technologies at the board level. This provides seamless operation with the System Galaxy software that is convenient and cost-effective.

Galaxy Control Systems develops, manufactures and assembles all of our equipment in the United States. This means we have the greatest measure of control over quality and the availability of parts. And our ability to maximize long-term compatibility with existing technology makes Galaxy clearly the best choice for your security.

Galaxy extends its compatibility to US government listings and compliances including HSPD-12/FIPS 201, FICAM APL Certification Numbers 10060, 10083, 10084, 10097, 10098; PIV/PIV-II, CAC, and TWIC, as well as GSA/GSA Advantage and DIACAP Certification.

### Supported Hardware Features:

- Expandable, modular design
- Real-time, on-site or remote operation
- Built-in Surge Protection
- Supervised Communication
- Remote Output Control
- Alarm Priority Levels
- Input/Output Linking
- Selectable LED Behavior (reader)
- Supports Biometric Identification & Authentication
- Supports Wireless Reader Technologies
- Protects Personnel, Visitors, Buildings, Equipment and other Assets

# SYSTEM DIAGRAM

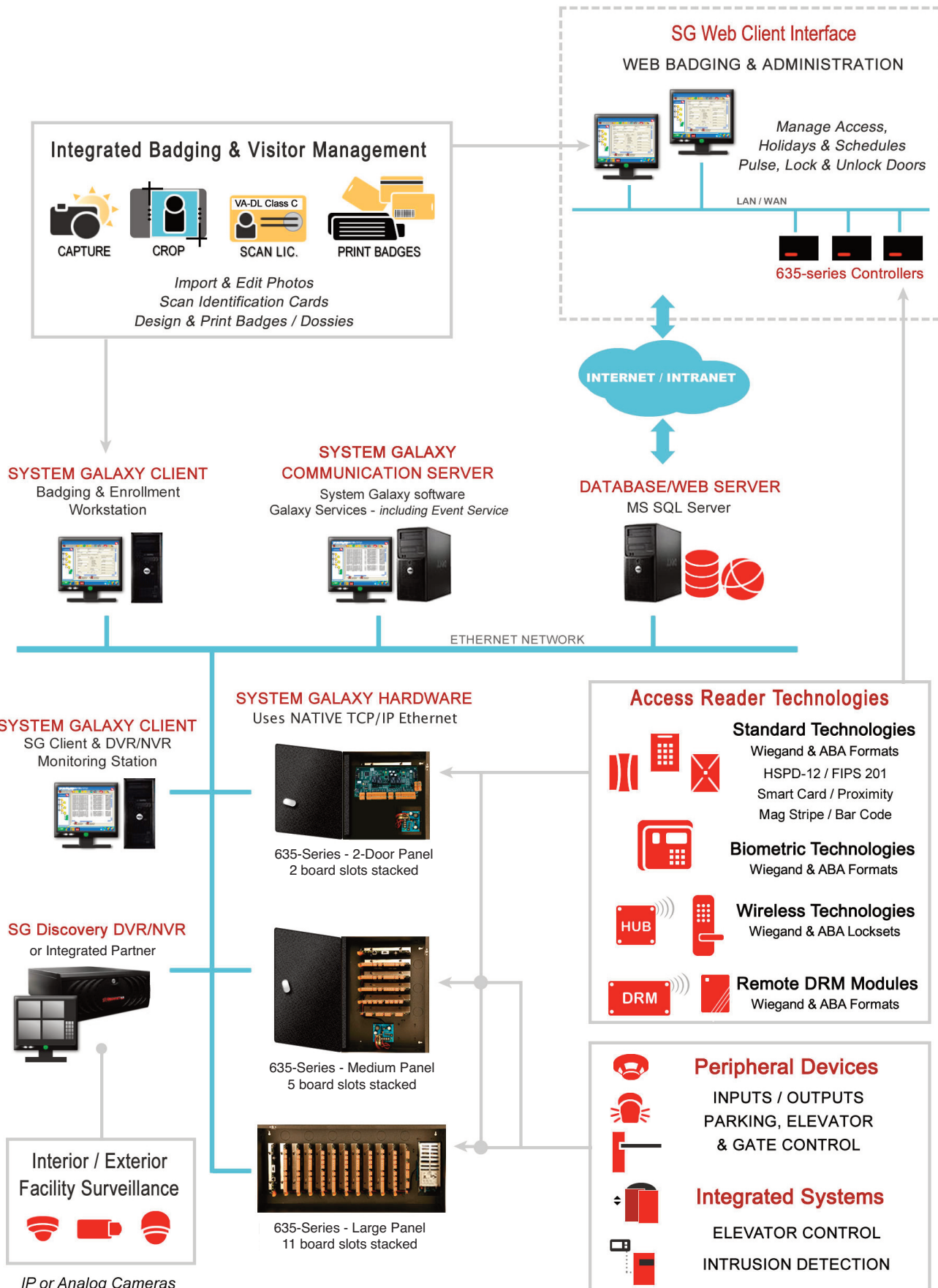

# 635-SERIES CONTROL PANELS

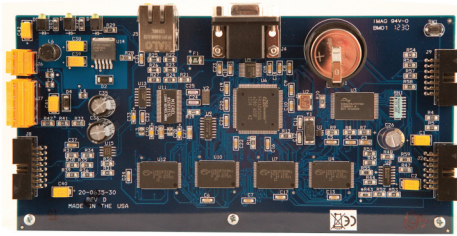

The 635-series **Central Processing Unit (CPU)** manages the access rules, schedules, and cards, as well as handling event data to and from the peripheral hardware (doors, readers, inputs and outputs, etc.). This allows the controller, interface boards, and hardware to work seamlessly with the System Galaxy software and remain fully functional when operating independently of the software.

## Control Panel Features:

- LAN/WAN capable via Native TCP/IP
- 10,000 event buffer per panel
- 50,000 card/user capacity
- 254 time schedules (per cluster)
- 256 I/O Groups (per cluster)
- 2000 access groups and/or unlimited personal doors (per cluster)
- Scheduled lock/unlock
- Programmable duress
- Programmable temporary cards
- Programmable temporary access groups
- Unlimited holidays/special days
- Two-man access rule
- Interface boards are hot-swappable

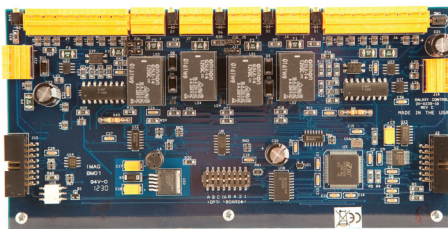

**Door Reader Module:** The DRM board has two independent reader ports per board and two relays for each reader port. The DRM offers supervision of door contacts and provides surge protection to guard against equipment damage from electrical spikes.

635 DRM provides an additional RS-485 port, which allows it to be remotely distributed over doors in multi-drop configuration.

## STANDARD CARDS

- Proximity 125KHz
- Barcode
- Magnetic Stripe

## SMART CARDS

- HID® iClass®
- MIFARE®
- MIFARE DESFire™
- MIFARE DESFire™ EV1

## SUPPORTS:

- 2 readers (doors) per DRM
- 16 readers per DSI-485 port;
- Biometric Identification and Authentication

## US GOVERNMENT COMPLIANT

- HSPD-12 & FIPS 201 Compliant
- FICAM Approved APL Certification Numbers 10060, 10083, 10084, 10097, 10098
- PIV, PIV-II, TWIC cards
- CAC-Legacy, Transition, Endpoint
- Option to perform PKI challenge to the Personal Certificate (PAK)

***All 635-series interface boards are 'hot swappable' and intelligent. You can change or add boards while the panel is powered up and operating. And the intelligent design means the boards will synchronize to the system and begin operating within minutes. This provides uninterrupted security during maintenance and upgrades.***

# 635-SERIES CONTROL PANELS

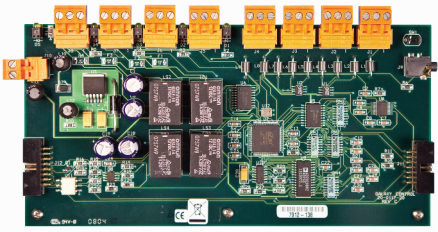

**Digital Input/Output Board (DIO):** The DIO board controls inputs & outputs with user-defined schedules and an extensive array of configurable options. The DIO board reports the appropriate input status and alarm event (trouble or safe) based on configuration.

Supervision of inputs is supported by the DIO board. And as an added layer of protection, the DIO also offers an on-board feature, known as Hypervision, which protects the supervision from being defeated.

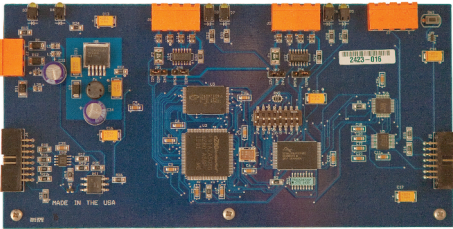

**Dual Serial Interface (DSI) Interface Board:** The DSI board is designed as a 3rd party integration solution for devices using RS-485 protocol. There are two RS-485 ports per board that support RS-485 devices in a single or multi-drop configuration. The board supports wireless reader technology, relay controls, LCD displays and Galaxy RS-485 Remote DPI modules.

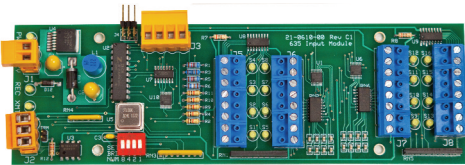

**Alarm Monitoring Module:** The Alarm Monitoring Module allows the system to monitor different devices (i.e. alarms, motion detectors, temperature sensors, etc.), and notify the system operator of any changes in condition (i.e. forced entry, low temperature, etc.). The module simply connects to DSI Board though RS-485 and can monitor up to 16 different devices per module. Up to 16 modules can be daisy chained for total of 256 devices per DSI channel.

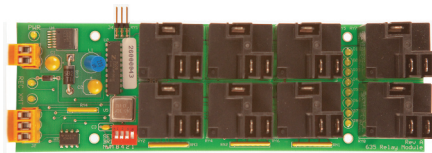

**General Relay & Elevator Relay Interface Boards:** Relay boards can be used to drive General Relay Outputs or Elevator Relay Outputs. The Relay board supports eight relays per board and interoperates with the Galaxy DSI board using RS-485 protocol in a multi-drop configuration.

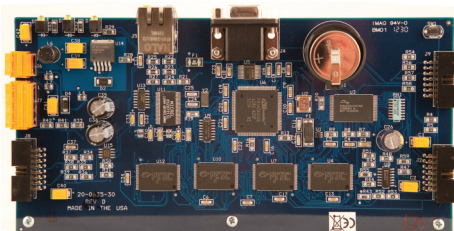

**Otis Elevator Interface (OEI) Interface Board:** The OEI board integrates access control with the Otis Compass™ System using native UDP/IP. The OEI manages Otis DEC Modes, supports Otis Floor Groups and Special Flags (i.e. Handicap, VIP, Split Group, etc.).



**The USB Enrollment Reader:** The fastest, and most convenient way to add or replace access cards. Simply connect it to the PC's USB port, and any industry standard access card can be entered into the system. It is available with Proximity, Wiegand, Magnetic Stripe, or US Government Readers for FIPS 201. The USB Reader also features an interface that allows the connection of any industry standard reader for entering different types of cards.



**Galaxy LCD Display:** The LCD module provides custom messages to cardholders at the point of access. The unit displays alpha-numeric characters on backlit LCD screen. The unit can display a maximum of 80 characters on a 4-line display as well as several formats of date/time and decrementing card-swipes, which can be used for greetings, time clocks and parking lot applications. The unit uses RS-485 protocol in a multi-drop configuration via the Galaxy DSI board.

# PARTNERED SOLUTIONS

Galaxy Control Systems expands its offerings to include solutions from leading manufacturers. This gives Galaxy customers the advantage of using the best in wireless solutions, biometric technologies and intrusion detection systems.

**Biometric Solutions:** Galaxy integrates with the full product line of Sagem MorphoAccess™ indoor and outdoor readers for identification (1:1) and authentication (1:n). Galaxy also supports integration with L1-Identity's 4G-series biometric readers. The System Galaxy software seamlessly supports reading and writing biometric data on Philips MIFARE® smart cards and HID® iClass® cards, including BIO-PIN for people whose prints are difficult to identify.

**Wireless Solutions:** Galaxy partners with SCHLAGE® and ASSA ABLOY to offer superior wireless solutions. The 635-series DSI serial interface board provides reliable integration with the SCHLAGE® AD-400 series and ASSA ABLOY Aperio™ products. Each RS-485 port on the Galaxy DSI board can support up to 16 wireless communication devices in a multi-drop configuration, affording the most flexibility when accommodating the structural design of any facility.

**Intrusion Detection Systems:** Galaxy integrates with intrusion detection systems from Honeywell-Bosch and Ademco. By opening our product offerings to include intrusion detection, Galaxy provides a localized and consolidated solution for monitoring and reporting events.



# WALL MOUNT CONTROLLERS

## SPECIFICATIONS

### Input Power

- 2-door controller – 2 amps
- 2-door POE - 15/30 watts
- 8-door controller – 2 amps
- 16-door controller – 10 amps

### Relay Outputs

- Form-C contacts,
- 24 VAC, 1.5 amps max

### Temperature Range

- 10° C to +60° C, non-condensing

### Communications

- TCP/IP; 10/100 Mbps

### Certifications

- UL 294, UL 1076
- UL 294C, UL 1076C
- CE EN-50133
- FICAM Approved APL Certification Numbers:  
10060, 10083, 10084, 10097, 10098
- RoHS Compliant

### Enclosure Dimensions

- 18 ga electrical cabinet, hinged
- 2-door controller (12" x 12" x 4")
- 8-door controller (18" x 13.75" x 6.25")
- 16-door controller (32" x 13.75" x 6.25")
- 2-door remote DRW (7.1" x 10" x 3.5")

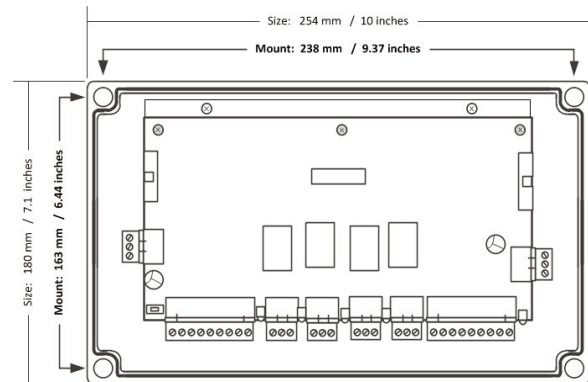
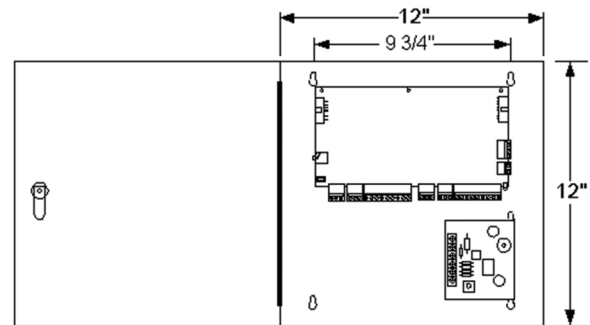
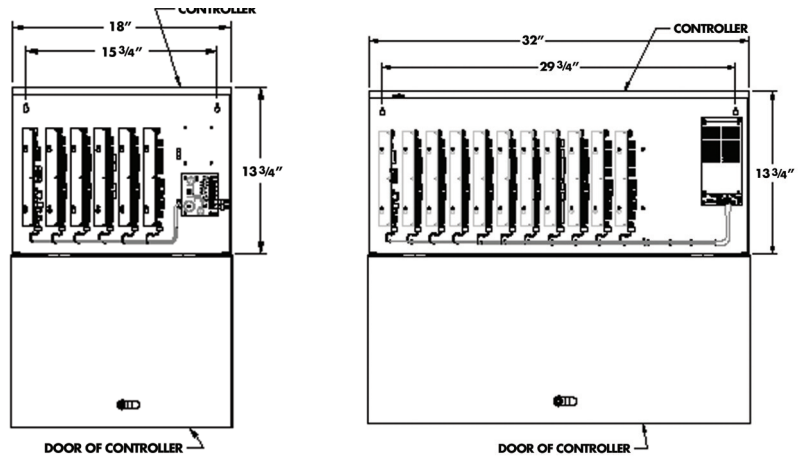

Remote Door Module / 635-series DRM  
(Clearance: 90 mm / 3.5 inches)

# RACK MOUNT CONTROLLER

## SPECIFICATIONS

### Electrical

- Power Requirements 85/264 VAC,
- 60/50 Hz, 220 Watts

### Physical Dimensions

- (HxWxD) 7x19x18.75 in (18 x 49 x 48 cm)
- Std. Rack Units – 4 units
- Weight – 26 lbs (11.79 kg)

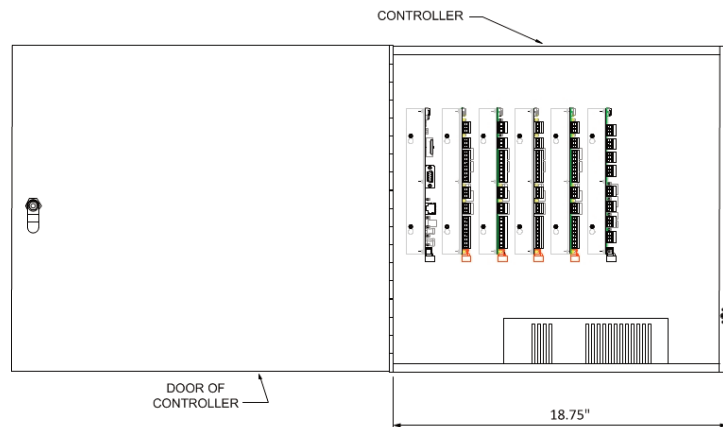



## Corporate Commitment to Excellence

Galaxy Control Systems was established to bring innovative solutions to the security market. Since 1984, Galaxy has maintained an unwavering commitment to excellence in developing access control and security management solutions that seamlessly integrate with advancing technology from leading industry partners.

Dedication to product development is only part of the business philosophy at Galaxy Control Systems. All Galaxy products are manufactured in the United States to rigorous military standards for the utmost quality and reliability. The company also offers total support to its customers through an extensive national and international network of highly trained, factory-authorized dealers.

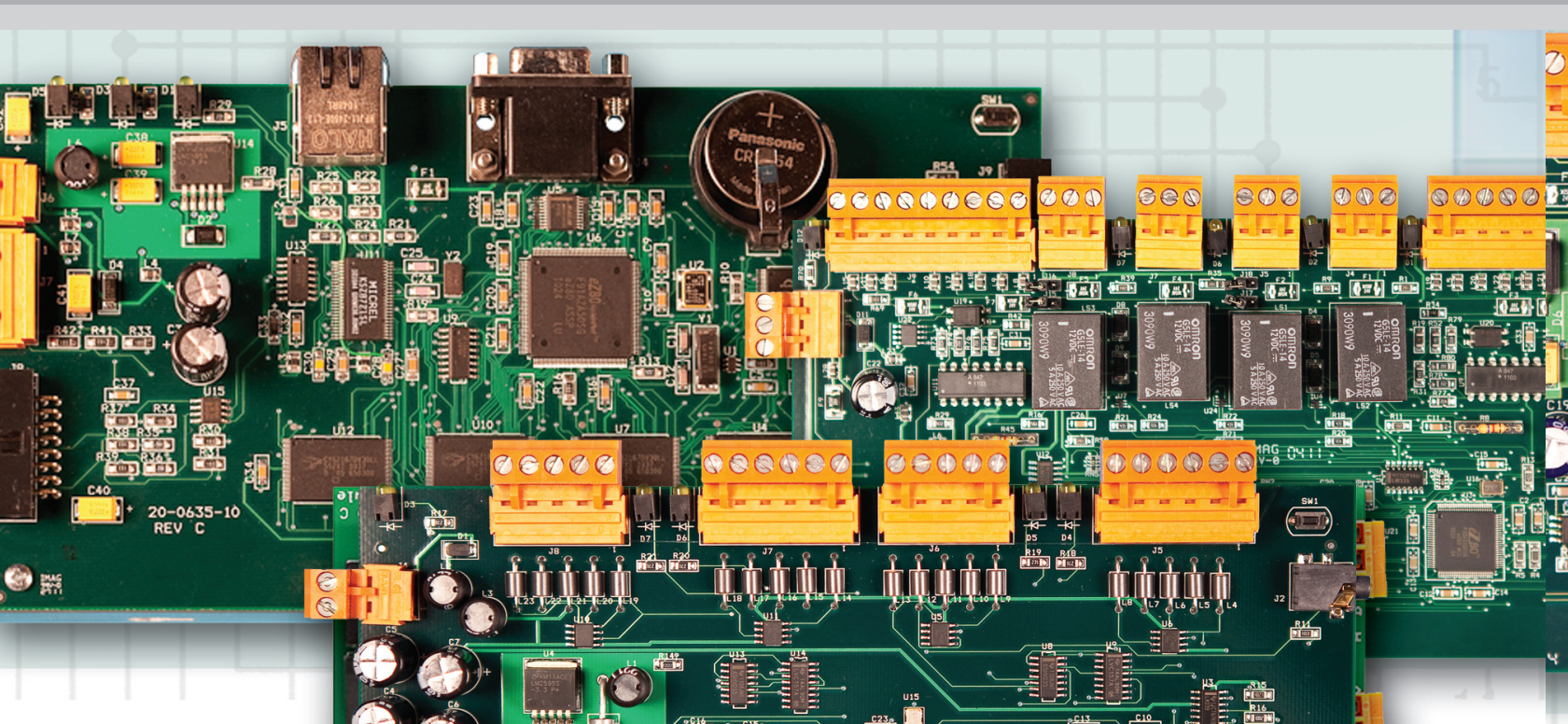

Mailing: PO Box 158 Walkersville, MD 21793 • Shipping: 3 N Main St. Walkersville, MD 21793  
Phone: 301-845-6600 • Fax: 301-898-3331 • E-mail: [orders@galaxysys.com](mailto:orders@galaxysys.com), [info@galaxysys.com](mailto:info@galaxysys.com)